



**Flüssiggas-Anlagen**

## **»Group 21«**

**Compressors**

**Pumps**

**Accessories**

**Complete Units and Packages**



Flüssiggas-Anlagen GmbH • Peiner Straße 217 • D - 38229 Salzgitter (Germany)

Tel. +49 (0) 53 41 / 86 97-0 • Fax +49 (0) 53 41 / 86 97-11

E-Mail: [info@fas-uni.de](mailto:info@fas-uni.de) • <http://www.fas-uni.de>



**Oil-Free Non-Lubricated Piston Compressor PN 40, type BLACKMER**, for transferring propane / butane from ocean tankers, rail tankers or road tankers to storage tanks, single compressor with drive V-belt pulley, suction and pressure gauge, oil pressure gauge without any further accessories, with inspection certificate 3.1.B to EN 10 204

Type: **A** = cylinder and head of ductile iron ASTM A536  
Type: **B** = cylinder and head of ductile iron GGG 40.3 in accordance to TRD 451, 452 und 108

**Executions with single piston rod seal (packing)**

Order No.	Type	Capacity (m <sup>3</sup> /h)
Type A	Blackmer	
21 104	161	26
21 105	361	58
21 106	601	100

**Executions with double piston rod seal (packing)**

Order No.	Type	Capacity (m <sup>3</sup> /h)	Order No.	Type	Capacity (m <sup>3</sup> /h)
Type A	Blackmer		Type B	Blackmer	
21 109	162	26	21 101	362-GGG	58
21 107	362	58	21 102	602-GGG	100
21 108	602	100	21 103	942-GGG	200

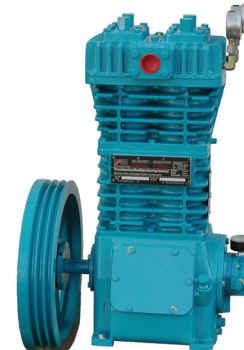

The compressor models 162, 362, 602 and 942 are equipped with a double piston rod seal (packing). These models are especially designed for indoor installations and in hazardous areas, as possible gas leaks can be drawn off without risk of contamination.

**Complete Oil-Free Non-Lubricated Piston Compressor Unit PN 25, type FAS / Blackmer**, for stationary systems, all fittings connected to steel pipeline, oil-free piston compressor with suction and pressure gauges, oil pressure gauge, mechanical liquid trap, strainer, 4-way ball valve, V-belt adjusting device, V-belt, V-belt pulley for motor, belt guard and threephase ex-proof motor 400/690 V / 50 Hz, EEx e II T3, IP 54, construction type B 3, mounted on a common steel base plate, ready for connection to plant facilities, completely welded, assembled, primed and painted, with inspection certificate 3.1.B to EN 10 204

Type: **A** = execution with **max. pressure switch** in pressure line for safe switching-off, setting 16 bar, TÜV-approval, ex-proof with **isolation switch amplifier** order no. **26 305**,  
Type: **B** = execution with **safety relief valve** in pressure line, setting pressure 19 bar, with TÜV-approval

**Compressor Cylinder and Cylinder Head of ductile iron ASTM A536**

Order No.	Order No.	Type	Capacity (m <sup>3</sup> /h)
Type A	Type B	Blackmer	
-	21 117	161	26
-	21 118	162	26
21 041	21 119	361	58
21 042	21 121	362	58
21 043	21 120	601	100
21 044	21 122	602	100

**Compressor Cylinder and Cylinder Head of ductile iron GGG 40.3**

Order No.	Order No.	Type	Capacity (m <sup>3</sup> /h)
Type A	Type B	Blackmer	
-	21 126	162-GGG	26
21 045	21 127	362-GGG	58
21 046	21 128	602-GGG	100
21 047	21 129	942-GGG	200

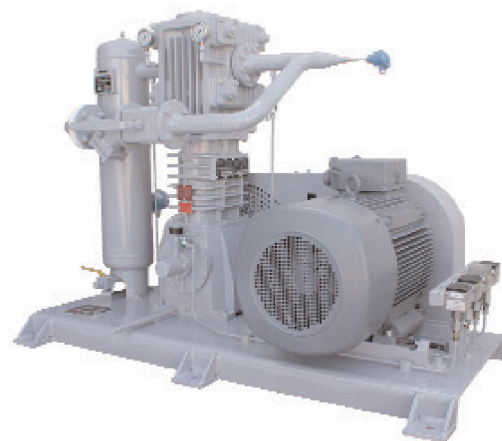

26 305 Isolation switch amplifier in safety engineering, with TÜV-approval

**Pressure Test Certificates for Compressors / Commissioning**

Order No.	Execution
21 190	Hydrostatic test at 52 bar, manufacturer's certificate for single compressor
21 197	TÜV-certificate for construction, pressure and tightness test for the complete compressor unit at 35 bar
21 087	Commissioning of the compressor unit

Additional equipment, as well as additional monitoring and control devices to TRB on request.  
Electrical switch cabinet for the control of a compressor unit available on request.

**Complete Non-Lubricated Piston Compressor Unit PN 25, type FAS / Blackmer for road tankers, with single piston rod seal (packing), compressor cylinder and cylinder head of ductile iron ASTM A536, all fittings connected to a steel pipeline, compressor unit with suction and pressure gauge, oil pressure gauge, mechanical liquid trap, strainer, 4-way ball valve, relief valve with TÜV-approval, as well as V-belt pulley on compressor, mounted on a common base plate, ready for connection to plant facilities, completely welded, assembled, primed and painted, with inspection certificate 3.1.B to EN 10 204**

Type: **A = without motor**  
Type: **B = with hydraulic motor**

Order No. Type A	Order No. Type B	Type Blackmer	max. Piston-Displacement (m <sup>3</sup> /h)
21 113	21 025	161	26 <sup>1)</sup>
21 114	21 026	361	58 <sup>1)</sup>

<sup>1)</sup> Capacity of the compressor at speed 790 RPM

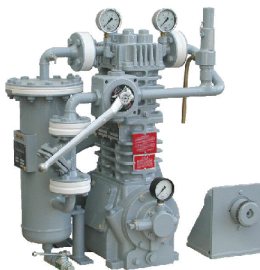

Execution B with type 161

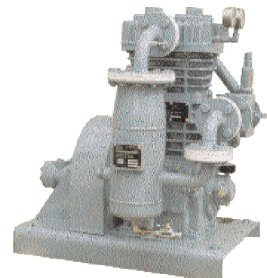

Execution B mit type 361

### Technical Data and Measurements

Compressor Type	161 <sup>2)</sup>	161	361 <sup>2)</sup>	361	601	162	362	602	942	
	Road Tanker		Road Tanker							
Connection	single compressor (female NPT)	3/4"	3/4"	1 1/4"	1 1/4"	1 1/2"	3/4"	1 1/4"	1 1/2"	2" ANSI
	complete unit (DIN - flange)	20	25	32	32	40	25	32	40	50
No. of cylinder		2		2		2	2	2	2	2 <sup>3)</sup>
Stroke (mm)		63		76		102	63	76	102	102
max. Piston Displacement - Capacity (m <sup>3</sup> /h)		26		58		100	26	58	100	200
min. inlet pressure (bar)		0,21		0,21	0,21	0,21	0,21	0,21	0,21	0,21
max. outlet pressure (bar)		24,1		20,7	22,4	24,1	22,4	20,7	27,0	29,0
Compressor speed (RPM)		790		790		770	790	790	770	790
max. power consumption (kW)		8,0		15,0		30,0	8,0	15,0	30,0	37,0
Motor capacity kW (FAS-Standard)		5,0		10,0		17,5	5,0	10,0	17,5	30,0
Dimensions (mm)	A	720	760	840	860	1135	770	980	1135	1250
	B	60	100	80	100	100	100	100	100	100
	C	455	530	640	640	778	530	640	778	900
	D1	550	-	630	-	-	-	-	-	-
	D2	-	1200	-	1320	1320	1200	1320	1320	1700
	E	370	400	510	510	510	400	510	510	655
	F	85	130	210	130	178	130	130	178	155
	G	345	435	375	639	601	435	639	601	650
	H	713	676	728	559	642	778	676	642	867
	I	607	570	622	454	530	672	571	530	763
Weight single compressor (kg)		104		153		322	109	170	327	410
Weight complete unit (kg)		140	265	214	400	630	270	430	650	990

<sup>2)</sup> Type A without motor

<sup>3)</sup> double-acting

Subject to technical alterations.

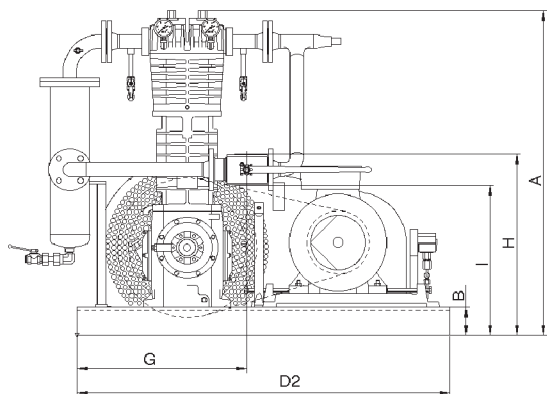

for stationary systems

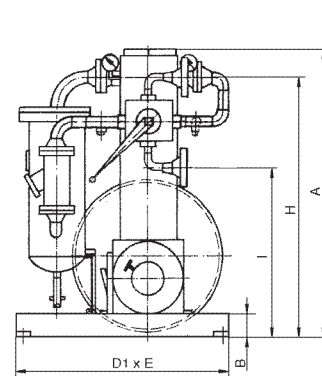
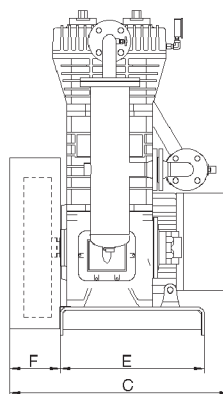

for road tankers

**Oil-free non-lubricated piston compressors, type Mehrer or Corken, spare parts and complete compressor units are available on request.**

**Oil-free non-lubricated piston compressor (air- or water-cooled) for carbon dioxide, nitrogen, ammonia and other petrochemical or industrial application are available on request.**

### Replacement Parts, Accessories and Safety Devices for Piston Compressors

**Mechanical Liquid Trap** PN 25, FAS model, of low temperature steel, with  $\frac{3}{8}$ " NPT ball valve of steel for release of liquid, construction to AD-requirements and TRB, with connection for attachment of electronic level sensor or pneumatic shutdown device, with inspection certificate 3.1.B to EN 10 204, with manufacturer's certificate or TÜV-approval

Order No.	For Type	Connection	Capacity	Weight
21 130 <sup>1+3)</sup>	161/162	DN 20	5,8 l	18,4
21 131 <sup>1+4)</sup>	161/162	DN 25	5,8 l	18,7
21 132 <sup>1)</sup>	361/362	DN 32	5,8 l	19,1
21 133 <sup>1)</sup>	601/602	DN 40	7,8 l	21,3
21 134 <sup>2)</sup>	942	DN 50	30,0 l	49,4

**26 135 Level sensor FTL 50** (for stationary systems), PN 25, 1" NPT male connection, approved for use in Ex-Zone 0, with PTB-certificate, sensor length: 66,5 mm

**26 136 Liquid level transducer FTL 320** (for stationary systems), with intrinsically safe electrical input and relay output, 1-channel, power supply 230 V AC, 50 Hz, built-in housing

**21 137 Shut down device, pneumatic**, PN 25 (for road tankers), 2" NPT male connection, pilot pressure 1,4 - 4,1 bar



Liquid trap, execution DN 20 bis DN 40

<sup>3)</sup> Execution for road tankers

<sup>4)</sup> Execution for stationary systems

**4-Way Ball Valve** PN 40, of steel, for propane / butane, to AD A4 requirements, seals of PTFE/Viton, with inspection certificate 3.1.B to EN 10 204

Type: **A** = with manual lever

Type: **B** = with pneumatic actuator  
pilot pressure 5 - 8 bar

Order No.	Weight	Order No.	Weight	Connection	For Type
Type A	Type A	Type B	Type B		
<b>with NPT-female thread</b>					
21 140 <sup>3)</sup>	5,1	21 240 <sup>3)</sup>	16,3	$\frac{3}{4}$ " NPT	161/162
21 141 <sup>4)</sup>	7,3	21 241 <sup>4)</sup>	18,5	1" NPT	161/162
21 142	7,3	21 242	18,5	1 $\frac{1}{4}$ " NPT	361/362
21 143	7,4	21 243	18,6	1 $\frac{1}{2}$ " NPT	601/602
<b>with flanges to DIN</b>					
21 147 <sup>3)</sup>	5,7	21 247 <sup>3)</sup>	16,9	DN 20	161/162
21 148 <sup>4)</sup>	7,1	21 248 <sup>4)</sup>	18,3	DN 25	161/162
21 149	12,5	21 249	23,7	DN 32	361/362
21 150	14,2	21 250	25,4	DN 40	601/602
21 144	16,1	21 244	27,3	DN 50	942

Special executions for other products are available on request.

#### Pneumatic Actuator for 4-Way Ball Valve

without automatic spring return, operating angle 90°, designed to handle a pilot pressure of 5 - 8 bar, complete with mounting bracket and screws

Order No. Execution for 4-way ball valve

21 180 with NPT-female thread (order no. 21 140 - 21 143)

21 020 with flanges to DIN DN 20 - 32 (order no. 21 147 - 21 149)

21 181 with flanges to DIN DN 40 - 50 (order no. 21 150 and 21 144)

#### Accessories for Pneumatic Actuator

**21 200 Limit Switch** in enclosure, explosion-proof, for OPEN/CLOSED position indication, without display

**19 748  $\frac{5}{2}$ -way solenoid valve**, explosion-proof, with Namur interface, for compressed air max. 10 bar, G  $\frac{1}{4}$ " threaded connection, operating voltage **230 V-AC**, 50 Hz

**19 749  $\frac{5}{2}$ -way solenoid valve**, explosion-proof, with Namur interface, for compressed air max. 10 bar, G  $\frac{1}{4}$ " threaded connection, operating voltage **24 V-DC**

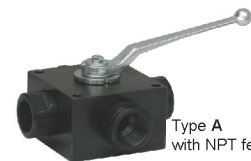

Type A with NPT female thread

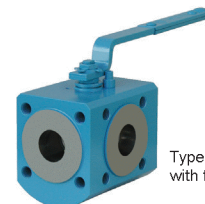

Type A with flanges to DIN



Type B with NPT female thread



Type B with flanges to DIN

**Relief Valve** PN 40, with soft seal, angular type, for stationary systems, body of ductile iron GGG 40, set at 19 bar, with type approval and with TÜV-certificate

Order No.	Inlet	Outlet	Weight
21 145	G $\frac{3}{4}$ " male	G $\frac{1}{2}$ " female	2,3



**Replacement Parts, Accessories and Safety Devices for Piston Compressors  
Temperature Monitoring Devices in Compressor Outlet**

- |                  |   |
|------------------|---|
| <b>Order No.</b> | <b>Execution</b>  |
| <b>26 312</b>    | <b>Resistance Thermometer PT 100</b> , M18 x 1,5 male connection, stainless steel probe Ø 6 mm, length 100 mm, 3-wire-connection, for monitoring temperature of compressed gas  |
| <b>26 313</b>    | <b>Measuring Amplifier</b> , intrinsically safe inlet (E Ex i), with relay outlet for two limits 110°C/130°C, with temperature indication, operating voltage 24 V-DC, European standard size board to DIN 41494, for installation in 19" rack   |
| <b>26 314</b>    | <b>Measuring Amplifier</b> , intrinsically safe inlet (E Ex i), with relay outlet for two limits 110°C/130°C, with temperature indication, with voltage and current outlet for additional level indicator, operating voltage 24 V-DC, European standard size board to DIN 41494, for installation in 19" rack |
| <b>26 315</b>    | <b>Enclosure for Electrical Control Cubicle</b> for holding board (for 26 313 and 26 314)   |
| <b>26 316</b>    | <b>Welding Thermometer Well</b> for temperature sensor to DIN 43769. Form D1, material C 22.8, with inspection certificate 3.1.B to EN 10 204   |



Order-No. 26 312



Order-No. 26 313/314



Order-No. 26 315

**Pressure Monitoring Devices** for compressor suction and discharge line (see also page 40)

**High Pressure Switch, setting range 4 - 25 bar, set at 15 bar**

- |                  |   |
|------------------|---|
| <b>Order No.</b> | <b>Execution</b>  |
| <b>18 456</b>    | <b>Pressure Switch</b> without explosion protection, G 1/2" male connection, aluminium housing, protection class IP 54, switching contact 1 change-over, breaking capacity 5 A/250 V AC, breaking difference not adjustable, explosion-proof when used in conjunction with isolating switch amplifier order no. <b>26 301</b> (230 V) or <b>26 303</b> (24 V) |

**Low Pressure Switch, setting range 0,5 - 6 bar, set at 0,8 bar**

- |                  |   |
|------------------|---|
| <b>Order No.</b> | <b>Execution</b>  |
| <b>18 457</b>    | <b>Pressure Switch</b> without explosion protection, G 1/2" male connection, aluminium housing, protection class IP 54, switching contact 1 change-over, breaking capacity 5 A/250 V AC, breaking difference not adjustable, explosion-proof when used in conjunction with isolating switch amplifier order no. <b>26 301</b> (230 V) or <b>26 303</b> (24 V) |

**Pressure Switch for Oil-Pressure Control, setting range 0,5 - 6 bar, set at 1 bar**

- |                  |   |
|------------------|---|
| <b>Order No.</b> | <b>Execution</b>  |
| <b>18 462</b>    | <b>Pressure Switch</b> without explosion protection, G 1/2" male connection, aluminium housing, protection class IP 54, switching contact 1 change-over, breaking capacity 5 A/250 V AC, breaking difference not adjustable, explosion-proof when used in conjunction with isolating switch amplifier order no. <b>26 301</b> (230 V) or <b>26 303</b> (24 V) |

**Accessories for Pressure Switch**

- |                  |   |
|------------------|---|
| <b>Order No.</b> | <b>Execution</b>  |
| <b>21 195</b>    | <b>Bracketry</b> for securing pressure switch to steel base plate including pulse conductors and assembly |

**Flexible Hose PN 40**, stainless steel, lapped flanges on both sides to DIN 2656 of carbon steel, welded execution, with single stainless steel covering, for flexible connection of compressors to system with inspection certificate 3.1.B to EN 10 204

Order No.	Connection	Length	Weight
<b>21 191</b>	32	1000	5,0
<b>21 192</b>	40	1000	6,3
<b>21 193</b>	50	1000	7,6



Mounting in a max. 90° angle recommended

Other designs, lengths and sizes are available on request.

**Mechanical Liquid Trap PN 25**, steel, with NPT female thread, with test report 2.2 to EN 10 204

Order No.	BLACKMER	Order No.	CORKEN	Connection	Capacity	Weight
<b>21 171</b>	161/162	<b>21 170</b>	290/291/D291	1 1/4"	9,7	14,4
	361/362		490/491/D491			
<b>21 172</b>	601/602	-	-	1 1/4"	13,0	16,3



**Complete Repair Set for piston compressors**

Order No.	Type	Order No.	Type	Order No.	Type	<b>Repair kit consists of:</b>	
	<b>BLACKMER</b>		<b>BLACKMER</b>		<b>CORKEN</b>	Quantity	Description
<b>21 151</b>	161	<b>21 157</b>	601	<b>21 163</b>	290/291	1	complete set of suction valves
<b>21 152</b>	162	<b>21 158</b>	602	<b>21 164</b>	D291	1	complete set of discharge valves
<b>21 153</b>	361	<b>21 159</b>	602A	<b>21 165</b>	490/491	6	piston rings
<b>21 154</b>	362	<b>21 161</b>	942	<b>21 166</b>	D491	6	expander rings
<b>21 155</b>	362B			<b>21 167</b>	690/691	1	complete seal kit
				<b>21 168</b>	D691	1	complete set of piston rod seals (packings)
						2	bearing connection rods

We supply all spare parts for BLACKMER and CORKEN compressors from stock. We are an authorized service workshop and specialized to repair and to service LPG compressors. For further information please contact us.

### Mobile Compressor Unit PN 25, Type FAS

For use in explosion-proof zone and hazardous area, completely mounted on a two-axle hand-cart, consisting of: non-lubricated piston compressor unit with explosion-proof threephase motor 400/690 V, 50 Hz, with suction and pressure gauges, including pressure monitoring devices for min. and max. pressure, oil pressure gauge, mechanical liquid trap with electronic liquid sensor, strainer, with manually actuated 4-way ball valve, all fittings are connected to a steel pipeline, V-belt adjusting device, V-belt, V-belt pulley for driving motor, belt guard, including explosion-proof electrical control cubicle (flame-proof) with 30 meter 5-core cable and 2 high-pressure hoses LPG 32 with 12 meter length, completely mounted on a common base plate including holding device for hoses, ready for connection to plant facilities, welded, assembled, primed and painted, with test report 2.2 to EN 10 204

Type: **A** = with **single** piston rod seal (packing), **standard design**  
Type: **B** = with **double** piston rod seal (packing)

Order No.	Type	Capacity (m <sup>3</sup> /h)
Type A	Blackmer	
21 221	161	26
21 223	361	58
21 226	601	100

Order No.	Type	Capacity (m <sup>3</sup> /h)
Type B	Blackmer	
21 222	162	26
21 224	362	58
21 227	602	100
21 234	942	200



### Pressure Test Certificates

Order No.	Execution
21 190	Hydrostatic test at 52 bar, manufacturer's certificate for single compressor
21 197	TÜV-certificate for construction, pressure and tightness test for the complete compressor unit at 35 bar

Further combinations according to customer's specifications are available on request.

Accessories for the liquid phase, like LPG high-pressure hoses, sight flow indicators, strainers and excess flow valves mounted on a separate hand cart, as well as further mobile compressor units with additional safety and control devices are available on request.

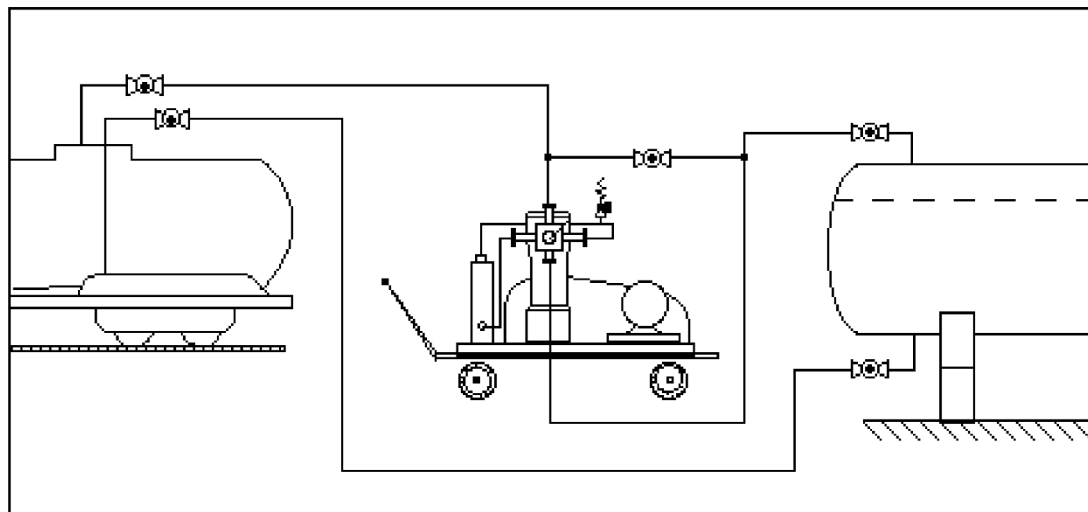

**Blackmer Rotary Vane Pump PN 25, for positive suction heads, case of ductile iron ASTM A536, for LPG filling stations, road tankers and stationary systems, with single-acting mechanical seal and one free shaft, with test report 2.2 to EN 10 204**

Type: **A** = right-hand rotation, with NPT-thread, from 2" - with NPT threaded flanges, **standard model**  
 Type: **B** = right-hand rotation, flanges with weld ends  
 Type: **C** = left-hand rotation, with NPT-thread, from 2" - with NPT threaded flanges  
 Type: **D** = left-hand rotation, flanges with weld ends

Order No.	Order No.	Order No.	Order No.	Type	Connection	Capacity <sup>1)</sup> l/min	Differential Pressure max. bar	Weight (kg)
Type A	Type B	Type C	Type D					
21 301 <sup>2)</sup>	-	-	-	LGB 1" C	1"	20	8,6	9,0
21 302 <sup>2)</sup>	-	-	-	LGB 1" PC	1"	35	8,6	9,0
21 303	-	-	-	LGL 1 1/4"	1 1/4"	50	10,5	14,0
21 304	-	-	-	LGL 1 1/2"	1 1/2"	90	10,5	14,0
21 305	21 335	21 355	21 365	LGL 2" E	2"	220	10,5	40,0
21 306	21 336	21 356	21 366	LGL 3" E	3"	490	10,5	74,0
-	21 337	-	21 367	LGL 4"	4"	950	10,5	99,0
-	21 338	-	21 368	ZLGL3-HDP	3"	450	12,8	75,0



Type A  
LGL 1 1/4" und 1 1/2"

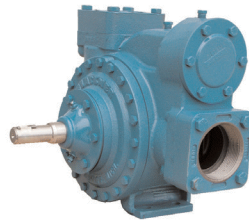

Type A + B  
LGL 2" bis LGL 4"

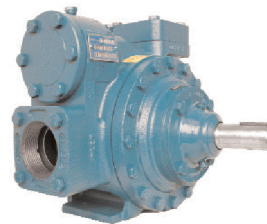

Type C  
LGL 2"

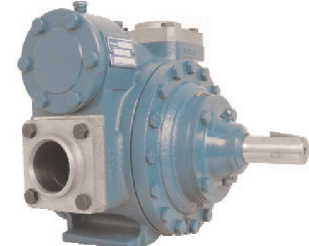

Type D  
LGL 2" bis 4"

**Blackmer-pumps in material ductile iron GGG 40.3 with inspection certificate 3.1 B to EN 10 204 see page 67.**

**Blackmer Rotary Vane Pump design as described above, with two free shafts (right-hand or left-hand rotation), with test report 2.2 to EN 10 204**

Type: **E** = with NPT threaded flanges  
 Type: **F** = flanges with weld ends

Order No.	Order No.	Type	Connection	Capacity <sup>1)</sup> l/min	Diff. Pressure max. bar	Weight (kg)
Type E	Type F					
21 320	21 321	TLGLD 2" E	2"	220	10,5	40,0
21 331	21 332	TLGLD 3" E	3"	490	10,5	74,0
21 333	21 334	LGLD 4"	4"	950	10,5	99,0

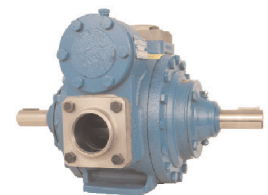

**Blackmer Pump Unit PN 25, for positive suction heads, pump case of ductile iron ASTM A536 with single-acting mechanical seal, complete unit mounted on a steel base plate, ready for connection to plant facilities, primed and painted, with explosion-proof motor 230/400 V, 50 Hz, 1500 min<sup>-1</sup>, E Exe II T 3, for motor sizes from 5 kW with gear motors 400/690 V, with coupling and coupling guard, with test report 2.2 to EN 10 204**

Order No.	Type	Motor kW	Capacity <sup>1)</sup> l/min	Pump Speed approx. min <sup>-1</sup>	Weight (kg)
21 311 <sup>2)</sup>	LGB 1" C	1,00	20	1500	32,0
21 312 <sup>2)</sup>	LGB 1" PC	1,00	35	1500	32,0
21 313	LGL 1 1/4"	2,00	50	1500	56,0
21 314	LGL 1 1/2"	2,00	90	1500	61,0
21 354 <sup>3)</sup>	LGL 1 1/2"	3,60	90	1500	64,0
21 315	LGL 2" E	5,00	220	560	160,0
21 316	LGL 3" E	10,00	490	580	230,0
21 317	LGL 4"	15,00	950	580	420,0
21 318	ZLGL3-HDP	15,00	450	580	390,0

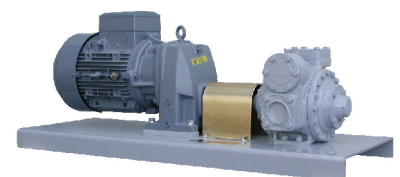
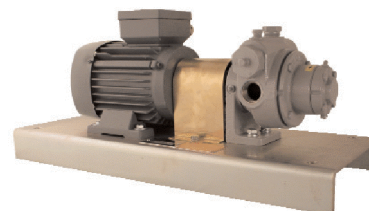

- <sup>1)</sup> Performance and capacity data recorded at a differential pressure of 5 bar
- <sup>2)</sup> These pumps are fitted with an internal bypass valve (for intermittent operation) with connection to back-to-tank line.  
For continuous operation an additional external bypass valve must be installed.
- <sup>3)</sup> This pump unit with higher motor capacity can reach a differential pressure of 10,5 bar

**All pumps can be fitted with motors with higher capacities and pump speeds.  
 Pump units with V-belt and V-belt guard are available on request.**

**We supply all spare parts for Blackmer pumps from stock and dispose of a fast and low-cost repair service for all Blackmer pumps.**

**Please ask for our spare parts and spare parts lists. When ordering spare parts, please state the pump model.**

**Blackmer Rotary Vane Pump PN 25, for positive suction heads, special design with case of ductile iron GGG 40.3, with single-acting mechanical seal and one free shaft, differential pressure max. 10,5 bar, with inspection certificate 3.1.B to EN 10 204**

Type: **A** = right-hand rotation, with NPT-thread, from 2" - with NPT threaded flanges, **standard model**  
 Type: **B** = right-hand rotation, flanges with weld ends  
 Type: **C** = left-hand rotation, with NPT-thread, from 2" - with NPT threaded flanges  
 Type: **D** = left-hand rotation, flanges with weld ends

Order No.	Order No.	Order No.	Order No.	Type	Connection	Capacity <sup>1)</sup>	Weight
Type A	Type B	Type C	Type D			l/min	(kg)
21 343	21 361	21 350	21 357	LGL 1 1/4"	1 1/4"	50	14,0
21 345	21 362	21 351	21 358	LGL 2" E	2"	220	40,0
21 346	21 363	21 352	21 359	LGL 3" E	3"	490	74,0
21 347	21 364	21 353	21 360	LGL 4" E	4"	950	99 0

**Blackmer Rotary Vane Pump** design as described above, with two free shafts, (right-hand or left-hand rotation), with inspection certificate 3.1.B to EN 10 204

Type: **E** = with NPT threaded flanges  
 Type: **F** = flanges with weld ends

Order No.	Order No.	Type	Connection	Capacity <sup>1)</sup>	Weight
Type E	Type F			l/min	(kg)
21 340	21 348	TLGLD 2"	2"	220	40,0
21 339	21 349	TLGLD 3"	3"	490	74,0

<sup>1)</sup> Performance data recorded at a differential pressure of 5 bar.



**New competitive and economic pump technology according to ATEX, with CE-mark for LPG installations and AUTOGAS filling stations**

**Capacity Features:**

- Design pressure: 40 bar
- Max. working pressure: 25 bar
- Max. capacity: 60 l/min
- Temperature range: -25°C to +80°C
- Ex-motor 230/400 V, 50 Hz, 2.5 - 3.3 kW 2900 RPM
- Low maintenance and operation cost
- Low noise
- Low investments
- Long lifetime
- Completely mounted and ready for connection with coupling and coupling protection
- Compact version
- For positive displacement pumps for aboveground tanks

Order No.	Execution	pump inlet	Max. differential pressure
91 770	Regenerative Turbine Pump	1" NPT thread	10 bar
21 755	Side channel pump	DN 12	12 bar

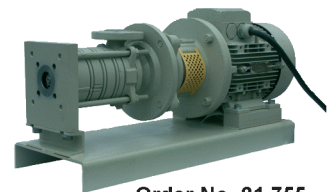

Order No. 21 755

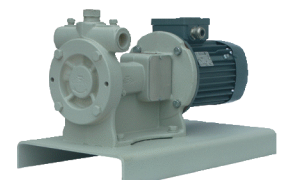

Order No. 91 770

**Blackmer Pump Unit with Hydraulic Motor PN 25, for positive suction heads, case of ductile iron ASTM A536, with single-acting mechanical seal, consisting of pump, hydraulic adapter, coupling and hydraulic motor, complete unit mounted without steel base plate, ready for connection to road tanker facilities, primed and painted, with test report 2.2 to EN 10 204**

Type: **A** = right-hand rotation<sup>1)</sup>, NPT threaded flanges  
 Type: **B** = right-hand rotation<sup>1)</sup>, flanges with weld ends

Order No.	Order No.	Type	Capacity <sup>2)</sup>	Pump Speed	Motor	Oil	Oil Pressure
Type A	Type B		l/min	min <sup>-1</sup>	kW	l/min	bar
21 571	21 575	TLGL 2"	220	650	5,0	16,0	244
21 572	21 576	TLGL 2"	220	650	5,0	52,0	100
21 573	21 577	TLGL 3"	490	650	10,0	28,6	232
21 574	21 578	TLGL 3"	490	650	10,0	52,0	160

<sup>1)</sup> Pump unit with left-hand rotation available on request.

<sup>2)</sup> Performance data recorded at a differential pressure of 5 bar

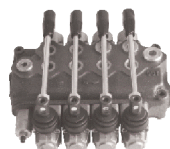

valves

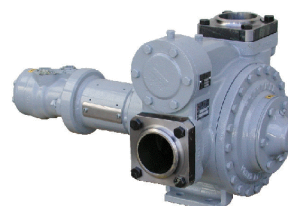

pump unit with hydraulic motor

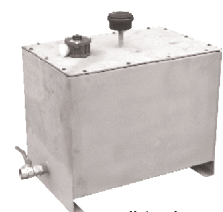

oil tank



Hydrive

**Accessories like valves, oil tanks, hydrives (coolers) and other parts are available on request.**



**LPG Submersible Pump PN 25**, for the delivery of LPG from underground and overground tanks, pump and explosion-proof motor 400 V/50 Hz (two parts unit), compact pump unit for direct installation into the liquid phase of the tank, motor with certificate of conformity, with test report 2.2 to EN 10.204

Type: **A = Submersible pump without additional equipment**, connection for discharge 2" female NPT

Order No.	Pump Type	Max. Differential Pressure	Max. Capacity at <sup>3</sup> p 8,0 bar	Capacity Motor kW	Weight Type A
<b>21 587</b>	LPG300V17-21	9 bar	50 l/min	2,20	42,0
<b>21 588</b>	LPG500V17-24	11 bar	130 l/min	3,75	50,0

Type: **B = Submersible pump without pump manifold**, with pressure line system and explosion-proof connecting box, pump connection flange DN 125 PN 40, outlet pressure line flange PN 40 to DIN 2635, pressure side with vent valve 1/4" NPT and pressure gauge with shut-off valve, differential pressure switch with switch amplifier as dry-run protection with shut-off valve, pressure line system constructed according to pressure vessel code, with TÜV approval, completely assembled ready for connection, primed and painted. Manifold length depending on tank diameter and submerged pipe connection according to customer's specification.

Type: **C = Submersible pump with pump manifold**, with pressure line system and explosion-proof connecting box, unit as described in type B including manifold with ball valve for manifold inlet, a flushing / discharging connection, with excess flow valve, safety relief valve, pressure gauge with shut-off valve and the extended shaft for the ball valve at the manhole inlet, pump manhole constructed according to pressure vessel code including TÜV approval, the test of welding seams on manhole cover has to be executed at site within the tank pressure test with the tank manufacturer, complete unit ready for connection to plant facilities, completely assembled, primed and painted, manhole cover<sup>2)</sup>, as well as manifold length depending on tank diameter<sup>2)</sup> and height of manhole nipple<sup>2)</sup> according to customer's specification.

<sup>1)</sup> Differential pressure switch is only explosion-proof, if used together with isolating switch amplifier. Therefore please advise required voltage of 230V-AV or 24V-DC.

<sup>2)</sup> The manifold diameter should be at least 478 mm. Please indicate or send tank drawings with order.

Tank diameter	Pump type <b>LPG300V17-21</b> Discharge connection DN 25		Pump type <b>LPG500V17-24</b> Discharge connection DN 32	
	Order No. Type B	Order No. Type C	Order No. Type B	Order No. Type C
1.250 mm	<b>21 801</b>	<b>21 802</b>	<b>21 811</b>	<b>21 812</b>
1.600 mm	-	<b>21 803</b>	-	<b>21 813</b>
2.000 mm	-	<b>21 804</b>	-	<b>21 814</b>
2.500 mm	-	<b>21 805</b>	-	<b>21 815</b>
on customer's request	<b>21 831</b>	<b>21 832</b>	<b>21 833</b>	<b>21 834</b>

Order No. **21 597** Additional service **Commissioning** at site, respectively training of the service personnel



Submersible pump with manifold and with pre-assembled fitting and valves for pressure and bypass line (**special design** - on request)

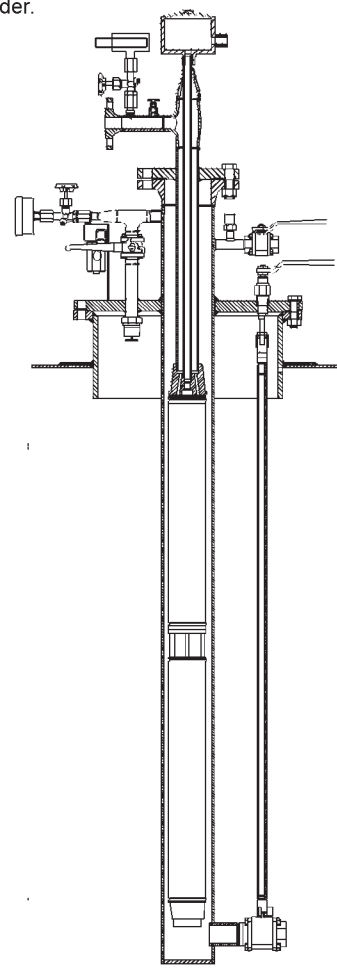

Type C = submersible pump with manifold

**LPG Side Channel Pump PN 25**, for **positive suction heads**, flange connection to DIN 2635, for stationary systems, with test report 2.2 to EN 10 204

Horizontal, self-priming side channel pump capable of handling liquid and vapour phases simultaneously, segmental-type, construction with open vane wheel impellers in addition to a pre-connected centrifugal stage in combination system for attaining favourable NPSH values.

**LPG Side Channel Pump Unit consisting of:** pump with explosion-proof threephase motor 230/400 V, from 5 kW 400/690 V, 50 Hz, EEx e II T3, pump speed 1500 min<sup>-1</sup>, completely mounted on a common steel base plate, ready for connection to plant facilities, primed and painted

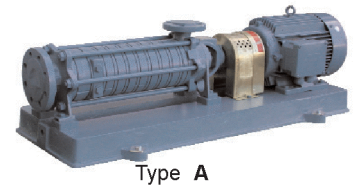

Type A

Type: **A = Pump unit with magnetic coupling - sealless -**, case of material **GGG 40.3**

Type: **B = Pump unit with single-acting mechanical seal**, case of material **GGG 40.3**, with coupling and coupling guard

Type: **C = Pump with free shaft and single-acting mechanical seal**, case of material **GGG 40.3**, without any further accessories

Type: **D = Pump unit with single-acting mechanical seal**, case of material **GG 25**, with coupling and coupling guard

Type: **E = Pump with free shaft and single-acting mechanical seal**, case of material **GG 25**, without any further accessories



Type C + E

Order No. Type A	Order No. Type B	Order No. Type C	Order No. Type D	Order No. Type E	No. of stages	Motor kW	Connection DN Inlet	Connection DN Outlet	Capacity m <sup>3</sup> /h
21 400	21 450	21 500	21 900	21 950	2	0,75	40	20	0,4 - 2,5
21 401	21 451	21 501	21 901	21 951	3	1,00			
21 402	21 452	21 502	21 902	21 952	4	1,35			
21 403	21 453	21 503	21 903	21 953	5	2,00			
21 404	21 454	21 504	21 904	21 954	6	2,00			
21 405	21 455	21 505	21 905	21 955	7	2,00			
21 406	21 456	21 506	21 906	21 956	8	2,50			
21 407	21 457	21 507	21 907	21 957	2	2,00	65	32	1,2 - 4,5
21 408	21 458	21 508	21 908	21 958	3	2,50			
21 409	21 459	21 509	21 909	21 959	4	3,60			
21 410	21 460	21 510	21 910	21 960	5	3,60			
21 411	21 461	21 511	21 911	21 961	6	5,00			
21 412	21 462	21 512	21 912	21 962	7	5,00			
21 413	21 463	21 513	21 913	21 963	8	6,80			
21 414	21 464	21 514	21 914	21 964	2	2,00	65	32	3,0 - 7,0
21 415	21 465	21 515	21 915	21 965	3	2,50			
21 416	21 466	21 516	21 916	21 966	4	3,60			
21 417	21 467	21 517	21 917	21 967	5	3,60			
21 418	21 468	21 518	21 918	21 968	6	5,00			
21 419	21 469	21 519	21 919	21 969	7	5,00			
21 420	21 470	21 520	21 920	21 970	8	6,80			
21 421	21 471	21 521	21 921	21 971	2	3,60	80	40	6,0 - 12,0
21 422	21 472	21 522	21 922	21 972	3	5,00			
21 423	21 473	21 523	21 923	21 973	4	5,00			
21 424	21 474	21 524	21 924	21 974	5	6,80			
21 425	21 475	21 525	21 925	21 975	6	10,00			
21 426	21 476	21 526	21 926	21 976	7	10,00			
21 427	21 477	21 527	21 927	21 977	8	10,00			
21 428	21 478	21 528	21 928	21 978	2	6,80	100	50	10,0 - 20,0
21 429	21 479	21 529	21 929	21 979	3	10,00			
21 430	21 480	21 530	21 930	21 980	4	13,50			
21 431	21 481	21 531	21 931	21 981	5	15,00			
21 432	21 482	21 532	21 932	21 982	6	15,00			
21 433	21 483	21 533	21 933	21 983	7	17,50			
21 434	21 484	21 534	21 934	21 984	8	24,00			
21 435	21 485	21 535	21 935	21 985	2	10,00	100	65	16,0 - 35,0
21 436	21 486	21 536	21 936	21 986	3	15,00			
21 437	21 487	21 537	21 937	21 987	4	24,00			
21 438	21 488	21 538	21 938	21 988	5	24,00			
21 439	21 489	21 539	21 939	21 989	6	30,00			
21 440	21 490	21 540	21 940	21 990	7	36,00			
21 441	21 491	21 541	21 941	21 991	8	44,00			

We supply replacement parts and repair faulty pumps in our own factory.  
Side channel pumps with ANSI-flanges are available on request.

**LPG Side Channel Pump Unit PN 25, for underground tanks, pump with magnetic coupling - sealless -, case of ductile iron GGG 40.3, for stationary systems, flange connection to DIN 2635, with test report 2.2 to EN 10 204**

horizontal, self-priming side channel pump unit capable of handling liquid and vapour phases simultaneously, segmental-type construction with open vane impellers in addition to a pre-connected centrifugal stage and integrated retaining stage for safe transfer of LPG from underground tanks, left-hand rotation when viewing the pump from the motor, horizontal suction flange, pressure flange vertically upwards. Pump complete with explosion-proof threephase motor 230/400 V, from 5 kW 400/690 V, 50 Hz, 1500 min<sup>-1</sup>, EEx e II T3, mounted on a common steel base plate, ready for connection to plant facilities, primed and painted

Order No.	Motor kW	Connection DN		No. of Stages	Capacity in m <sup>3</sup> /h at	
		Inlet	Outlet		<sup>3</sup> p 7,5 bar	<sup>3</sup> p 10 bar
21 560	2,5	40	20	7	1,0	0,6
21 561	6,8	65	32	7	3,2	2,6
21 562	10,0	80	40	7	4,9	3,9
21 563	24,0	100	50	7	9,0	7,2
21 564	44,0	100	65	7	18,0	14,8

**Vapour Eliminator Unit PN 25, suitable for mounting onto the connection flange on discharge side of the side channel pump, completely mounted with bypass valve with gastight cap and bellow, setting range 10 - 16 bar, bypass valve with hole-type screen for continuous vapour return into the storage tank, including a relief valve with setting pressure 25 bar and with a pressure gauge nipple G 1/2" left, flanges to DIN 2635, with manufacturer's certificate or TÜV-approval, Components with inspection certificate 3.1 B or test report 2.2 to EN 10 204**

Order No.	Inlet	Outlet	Capacity	Weight
21 214 <sup>1)</sup>	DN 20	DN 25	5 l	13,0
21 215 <sup>1)</sup>	DN 32	DN 32	5 l	14,0
21 216 <sup>1)</sup>	DN 40	DN 40	5 l	15,0
21 217 <sup>1)</sup>	DN 50	DN 50	7 l	17,0
21 218 <sup>2)</sup>	DN 65	DN 65	9 l	22,0

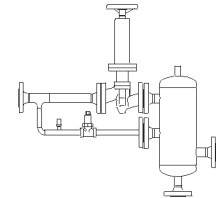

**LPG Side Channel Pump PN 25, for positive suction head, with single-acting mechanical seal, flange connection to DIN 2635, for stationary systems, case of ductile iron, right-hand rotation when viewing the pump from the shaft end, horizontal suction flange, pressure flange vertically upwards, with test report 2.2 to EN 10 204**

Type: **A = Pump with free shaft, without any further accessories, primed**  
 Type: **B = Complete unit, pump complete with explosion-proof motor 230/400 V, from 5 kW 400/690 V, 50 Hz, 1500 min<sup>-1</sup>, EEx e II T3, coupling and coupling guard mounted on a steel base plate, ready for connection to plant facilities, primed and painted**

Order No.	Order No.	Type	Capacity <sup>1)</sup>	Connection DN		Motor at	Weight	Weight
Type A	Type B		l/min.	Inlet	Outlet	Type B	Type A	Type B
21 492	21 732	SKC.2	12	50	25	2,0 kW	23,1	60,0
21 493	21 733	SKC.3	40	65	32	5,0 kW	40,5	112,0
21 494	21 734	SKC.4	60	65	32	6,8 kW	42,0	130,0
21 495	21 735	SKC.5	115	80	40	13,5 kW	68,0	210,0
21 496	21 736	SKC.6	175	80	40	15,0 kW	66,5	283,0
21 497	21 737	SKC.7	310	100	50	30,0 kW	105,0	474,0
21 498	21 738	SKC.8	460	100	65	44,0 kW	117,0	645,0

<sup>1)</sup> Performance data recorded at a differential pressure of 5 bar.

Further executions and accessories are available on request.

**Viking Gear Pump PN 25, for positive suction head, with single-acting mechanical seal, with internal bypass valve<sup>2)</sup>, right-hand rotation when viewing the pump from the shaft end. Standard assembly is with the intake on the right-hand side of the pump, case material GG 25, max. differential pressure 7 bar, max. operation pressure 17 bar, with test report 2.2 to EN 10 204**

Type: **A = Pump with free shaft, without any further accessories, primed**  
 Type: **B = Complete unit, pump complete with explosion-proof motor 230/400 V, 50 Hz, 1500 min<sup>-1</sup>, E Ex e II T3, coupling and coupling guard mounted on a steel base plate, ready for connection to plant facilities, primed and painted**

Order No.	Order No.	Type	Capacity <sup>1)</sup>	Connection	Bypass	Motor at	Weight	Weight
Type A	Type B		l/min.	female	connection	Type B	Type A	Type B
21 201	21 206	GG-4195	20	1" NPT	1/2" NPT	1,00 kW	9,0	30,0
21 202	21 207	HJ-4195	50	1 1/2" NPT	3/4" NPT	1,35 kW	20,0	46,0
21 203	21 208	HL-4195	75	1 1/2" NPT	3/4" NPT	2,00 kW	20,0	52,0

<sup>1)</sup> Performance data recorded at a differential pressure of 5 bar.

<sup>2)</sup> These pumps have an internal bypass valve (for continuous operation) with connection for return line to the tank, for continuous operation a separate bypass valve is required additionally (see page 55).



We supply spare parts and repair faulty pumps in our own factory.